

Data Sheet

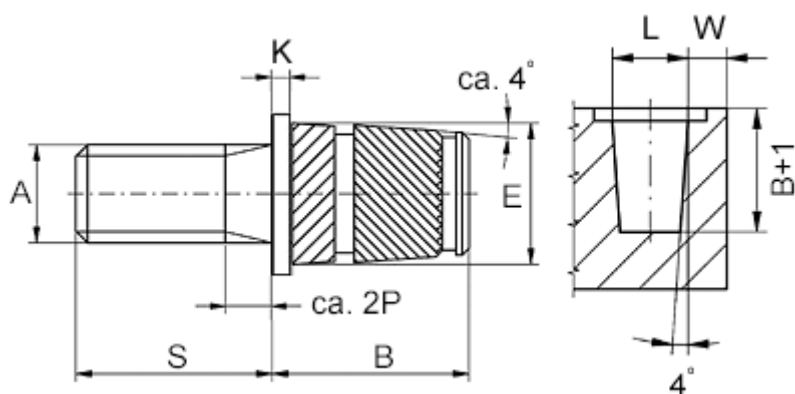

Article number: 12859100080820
Description: KLEE-coil 859 100 080.820
M8 Brass

Measures



Flange diameter E1	= 12.5
Flange height	= 1.3
Male thread A	= M8x1,25
Min distance to edge W	= 3.0
Mounting length B	= 13.3
Outer diameter E	= 11.2
Pin length S	= 6
Recommended bore diameter W +0.1	= 10.9